

**ZERO-MAX**

**Right Angle Crown® Gear Drives**



# HOW THE **CROWN RIGHT ANGLE GEAR DRIVE** WORKS

Crown two and three-way right angle gear drives transmit power with quiet, dependable spiral bevel gears.

Crown right angle gear drives feature hardened spiral bevel gears and non-magnetic stainless steel shafts. They are compact and feature multiple mounting options. The fully enclosed design ensures that internal gears can't get out of alignment, jam up or become contaminated by debris.

The cast aluminum housing is designed for maximum strength and heat dissipation. The drives are available with shafts of 3/8, 1/2, 5/8 and 3/4 inch diameter in two and three-way units with both 1:1 and 2:1 ratios. Three-way units in 1:1 and 2:1 ratios are available with 1 inch shafts. A wide variety of shafts are available including squared, splined, extended, shortened and stepped.

Applications include printing and packaging machines, off-highway vehicles and special machinery of all types.



## Features

## Benefits

Double sealed bearings.....	Holds lubrication in, keeps dirt out
Precision hardened and ground ball bearings.....	Smooth, quiet, long operating life
Non-magnetic stainless steel shafts.....	Corrosion resistant. Minimal maintenance
Aluminum alloy housing.....	Light weight, high strength and heat dissipation
Many standard types and sizes, plus special shafts.....	Get the exact model that fits your application needs
Multiple mounting positions.....	Simplifies design considerations
Proven design.....	Proven in thousands of applications for over 40 years

# HOW TO SELECT A **RIGHT ANGLE CROWN GEAR DRIVE**

- Determine Your Preferred Input/Output Ratio.** Standard ratios are 1:1 and 2:1. It is also possible to use a step up ratio of 1:2 by using shaft #2 as the input shaft. (See drawings on pages 3-5).
- Designate Which Shafts Are To Be Input And Output Shafts.** This step is especially important to determine that no shaft will turn faster than 2000 RPM. If shaft #2 in the 2:1 ratio models is selected as the input shaft, it can turn at a maximum of 1000 RPM. In the 1:1 ratio models it makes no difference. However, the choice in either case will affect your mounting.
- Be Certain That The Designated Output Shaft Has A Torque Capacity Greater Than Your Applications Load.** Consult the tables on the pages 6-8, and be sure to apply the service factors from the chart below.
- Choose Drive Type.** Use either 2-way or 3-way configuration.
- Select The Correct Model Number.** On pages 3-5, select the correct model number; note that units with 3/8 inch shafts have flats and units with 1/2, 5/8, 3/4 and 1 inch shafts have standard keyways. Also note that 1 inch shaft models are available in 3-way type only.
- If modifications of shafts and/or housings are required for your application,** send a drawing and a description of the application to the factory.

The Service Factors listed below will cover most usual applications. Applications dealing with single and multi-cylinder internal combustion engines, extreme repetitive shock loads and high energy loads are not covered. For additional information, please contact the factory.

Determine Prime Mover	Determine Duration of Service	Driven Machine Load Classifications		
		Uni-form	Mod. Shock	Heavy Shock
Electric Motor, Steam Turbine or Hydraulic Motor	Occasional 1/2 hr. /day	0.50	0.80	1.25
	Intermittent 3 hrs/day	0.80	1.00	1.50
	Over 3 hrs. up to 10 hrs/day	1.00	1.25	1.75
	Over 10 hrs/day	1.25	1.50	2.00



# THREE-WAY CROWN GEAR DRIVES

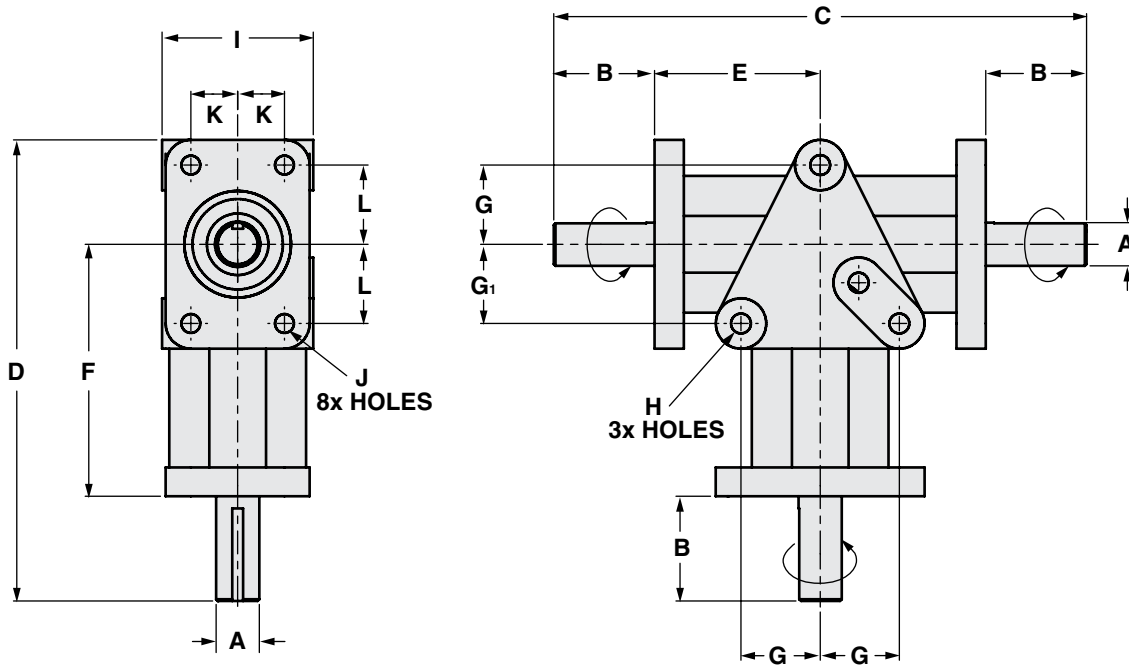

## Dimensions 1:1 Ratio

### Three-Way Crown Gear Drives Only

To obtain opposite shaft rotation for shafts 2 & 3 as shown, install (invert) Crown Drive with grease plug down.

Model	A	B	C	D	E	F	G	G <sub>1</sub>	H	I	J	K	L
C139801	0.375	0.63	4.06	3.66	1.41	2.19	0.66	0.66	0.221 dia.	1.50	0.166 dia.	0.50	0.66
C157806	0.500	1.00	5.75	4.94	1.88	2.88	0.88	0.88	0.281 dia.	1.75	0.265 dia.	0.56	0.81
C109806	0.625	1.50	7.00	6.19	2.00	3.25	1.13	1.13	0.281 dia.	2.13	0.265 dia.	0.69	1.13
C209806	0.750	1.75	9.25	7.94	2.88	4.38	1.38	1.38	0.344 dia.	2.63	0.328 dia.	0.81	1.38
C803806	1.000	2.75	12.00	11.00	3.25	6.00	1.75	2.75	0.406 dia.	4.00	3/8-16**	1.50	1.50

## 2:1 Ratio

Model	A	B	C	D	E	F	G	G <sub>1</sub>	H	I	J	K	L
C135801	0.375	0.63	4.06	3.66	1.41	2.19	0.66	0.66	0.221 dia.	1.50	0.166 dia.	0.50	0.66
C155806	0.500	1.00	5.75	4.94	1.88	2.88	0.88	0.88	0.281 dia.	1.75	0.265 dia.	0.56	0.81
C105806	0.625	1.50	7.00	6.19	2.00	3.25	1.13	1.13	0.281 dia.	2.13	0.265 dia.	0.69	1.13
C205806	0.750	1.75	9.25	7.94	2.88	4.38	1.38	1.38	0.344 dia.	2.63	0.328 dia.	0.81	1.38
C805806	1.000	2.75	12.00	11.00	3.25	6.00	1.75	2.75	0.406 dia.	4.00	3/8-16**	1.50	1.50

\*\*Tapped hole, .81" deep.

## Keyway Dimensions

Units with 3/8 inch dia. shafts ..... 1/32 Flat x 1/2 long  
 Units with 1/2 inch dia. shafts ..... 1/8 x 1/16 x 7/8  
 Units with 5/8 inch dia. shafts ..... 3/16 x 3/32 x 1-3/8

Units with 3/4 inch dia. shafts ..... 3/16 x 3/32 x 1-1/2  
 Units with 1 inch dia. shafts ..... 1/4 x 1/8 x 2

# TWO-WAY CROWN GEAR DRIVES

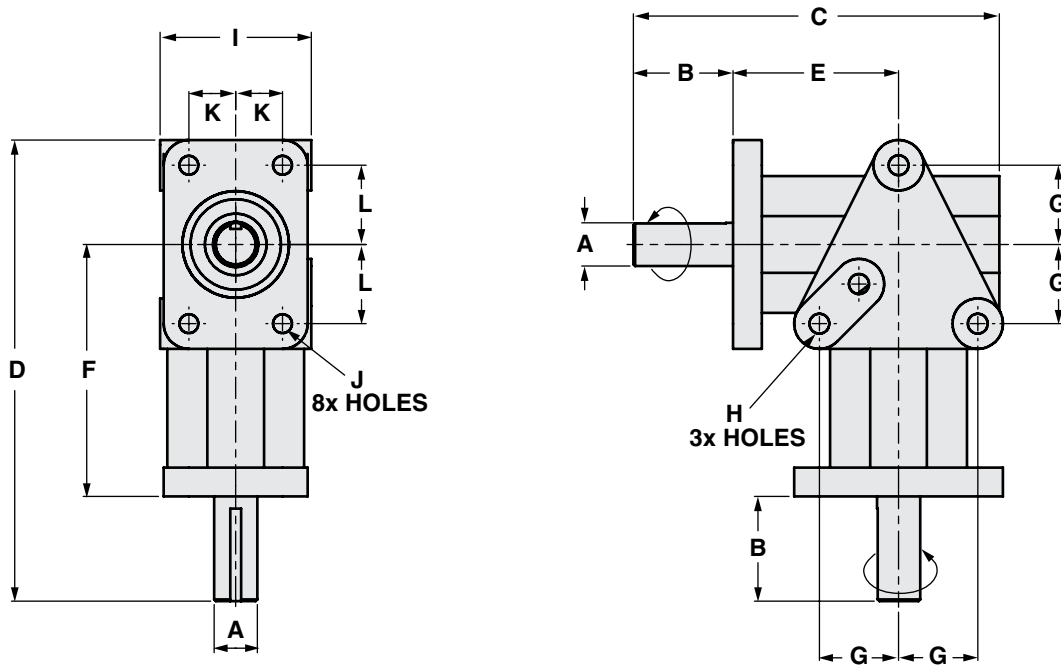

## Dimensions

### 1:1 Ratio

Model	A	B	C	D	E	F	G	H	I	J	K	L
C138801	0.375	0.63	3.16	3.66	1.41	2.19	0.66	0.221 dia.	1.50	0.166 dia.	0.50	0.66
C156806	0.500	1.00	4.38	4.94	1.88	2.88	0.88	0.281 dia.	1.75	0.265 dia.	0.56	0.81
C108806	0.625	1.50	4.88	6.19	2.00	3.25	1.13	0.281 dia.	2.13	0.265 dia.	0.69	1.13
C208806	0.750	1.75	6.38	7.94	2.88	4.38	1.38	0.344 dia.	2.63	0.328 dia.	0.81	1.38

### 2:1 Ratio

Model	A	B	C	D	E	F	G	H	I	J	K	L
C134801	0.375	0.63	3.16	3.66	1.41	2.19	0.66	0.221 dia.	1.50	0.166 dia.	0.50	0.66
C154806	0.500	1.00	4.38	4.94	1.88	2.88	0.88	0.281 dia.	1.75	0.265 dia.	0.56	0.81
C104806	0.625	1.50	4.88	6.19	2.00	3.25	1.13	0.281 dia.	2.13	0.265 dia.	0.69	1.13
C204806	0.750	1.75	6.38	7.94	2.88	4.38	1.38	0.344 dia.	2.63	0.328 dia.	0.81	1.38

## Keyway Dimensions

Units with 3/8 inch dia. shafts ..... 1/32 Flat x 1/2 long	Units with 3/4 inch dia. shafts ..... 3/16 x 3/32 x 1-1/2
Units with 1/2 inch dia. shafts ..... 1/8 x 1/16 x 7/8	Units with 1 inch dia. shafts ..... 1/4 x 1/8 x 2
Units with 5/8 inch dia. shafts ..... 3/16 x 3/32 x 1-3/8	

The right to make engineering refinements on all products is reserved. Dimensions and other details subject to change. When dimensions are critical, detailed drawings should be obtained from the factory. Dimensions are in inches.

# COUNTER-ROTATING **CROWN** GEAR DRIVES

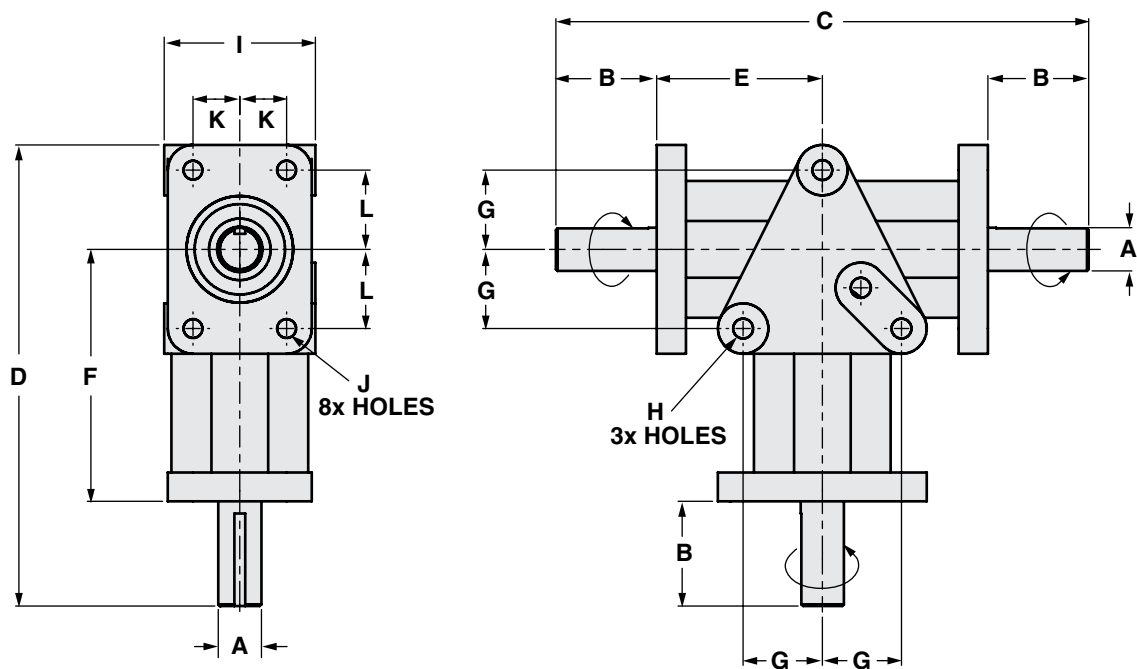

## Dimensions

### 1:1 Ratio

Model	A	B	C	D	E	F	G	H	I	J	K	L
C130801	0.375	0.63	4.06	3.66	1.41	2.19	0.66	0.221 dia.	1.50	0.166 dia.	0.50	0.66
C150806	0.500	1.00	5.75	4.94	1.88	2.88	0.88	0.281 dia.	1.75	0.265 dia.	0.56	0.81
C100806	0.625	1.50	7.00	6.19	2.00	3.25	1.13	0.281 dia.	2.13	0.265 dia.	0.69	1.13

### 2:1 Ratio

Model	A	B	C	D	E	F	G	H	I	J	K	L
C151806	0.500	1.00	5.75	4.94	1.88	2.88	0.88	0.281 dia.	1.75	0.265 dia.	0.56	0.81
C101806	0.625	1.50	7.00	6.19	2.00	3.25	1.13	0.281 dia.	2.13	0.265 dia.	0.69	1.13

NOTE: The suffix 806 designates units having Standard KEYWAYS.



New Zero-Max Configurable  
3D CAD Downloads.  
[www.zero-max.com](http://www.zero-max.com)

# CROWN RATED HORSEPOWER & TORQUE SPECIFICATIONS

## 3 Way

C139801		
3 way : 1 to 1 : 3/8" shaft		
Angular velocity	Rated Power	Rated Torque
RPM	H.P.	In. Lbs.
100	0.04	25
200	0.08	25
300	0.12	25
400	0.16	25
500	0.20	25
1000	0.38	24
2000	0.67	21

Ultimate static torque 160 in. lbs. calculated on 1,000 cycle basis.

C130801 (Counter Rotating)		
3 way : 1 to 1 : 3/8" shaft		
Angular velocity	Rated Power	Rated Torque*
RPM	H.P.	In. Lbs.
100	0.05	32
200	0.10	32
300	0.14	29
400	0.18	28
500	0.22	28
1000	0.42	26
2000	0.75	24

Ultimate static torque 170 in. lbs. calculated on 1,000 cycle basis.

\* This is the maximum torque that can be shared by both shafts at once.

C157806		
3 way : 1 to 1 : 1/2" shaft		
Angular velocity	Rated Power	Rated Torque
RPM	H.P.	In. Lbs.
100	0.07	46
200	0.14	46
300	0.22	46
400	0.29	46
500	0.36	45
1000	0.71	45
2000	1.27	40

Ultimate static torque 275 in. lbs. calculated on 1,000 cycle basis.

C150806 (Counter Rotating)		
3 way : 1 to 1 : 1/2" shaft		
Angular velocity	Rated Power	Rated Torque*
RPM	H.P.	In. Lbs.
100	0.08	50
200	0.16	50
300	0.25	50
400	0.33	50
500	0.41	50
1000	0.75	47
2000	1.37	43

Ultimate static torque 330 in. lbs. calculated on 1,000 cycle basis.

\* This is the maximum torque that can be shared by both shafts at once.

## 3 Way

C109806		
3 way : 1 to 1 : 5/8" shaft		
Angular velocity	Rated Power	Rated Torque
RPM	H.P.	In. Lbs.
100	0.16	101
200	0.32	101
300	0.47	99
400	0.62	98
500	0.75	95
1000	1.37	87
2000	2.43	77

Ultimate static torque 610 in. lbs. calculated on 1,000 cycle basis.

C100806 (Counter Rotating)		
3 way : 1 to 1 : 5/8" shaft		
Angular velocity	Rated Power	Rated Torque*
RPM	H.P.	In. Lbs.
100	0.17	107
200	0.30	95
300	0.45	94
400	0.60	94
500	0.75	94
1000	1.37	87
2000	2.50	79

Ultimate static torque 630 in. lbs. calculated on 1,000 cycle basis.

\* This is the maximum torque that can be shared by both shafts at once.

C209806		
3 way : 1 to 1 : 3/4" shaft		
Angular velocity	Rated Power	Rated Torque
RPM	H.P.	In. Lbs.
100	0.30	189
200	0.56	177
300	0.81	171
400	1.06	167
500	1.33	167
1000	2.33	147
2000	4.25	134

Ultimate static torque 1400 in. lbs. calculated on 1,000 cycle basis.

C803806		
3 way : 1 to 1 : 1" shaft		
Angular velocity	Rated Power	Rated Torque
RPM	H.P.	In. Lbs.
100	1.00	630
200	1.87	591
300	2.75	578
400	3.33	525
500	4.12	520
1000	7.75	488
2000	13.00	410

Ultimate static torque 5100 in. lbs. calculated on 1,000 cycle basis.

## 3 Way

C135801				
3 way : 2 to 1 : 3/8" shaft				
Angular velocity		Rated Power	Rated Torque	
Shaft 1	Shaft 2		Shaft 1	Shaft 2
RPM	RPM	H.P.	In. Lbs.	In. Lbs.
100	50	0.02	11	22
200	100	0.04	11	22
300	150	0.06	11	22
400	200	0.07	11	22
500	250	0.09	10	21
1000	500	0.16	10	20
2000	1000	0.30	9	18

Ultimate static torque 60 in. lbs. calculated on 1,000 cycle basis.

C155806				
3 way : 2 to 1 : 1/2" shaft				
Angular velocity		Rated Power	Rated Torque	
Shaft 1	Shaft 2		Shaft 1	Shaft 2
RPM	RPM	H.P.	In. Lbs.	In. Lbs.
100	50	0.03	20	39
200	100	0.06	20	39
300	150	0.09	20	39
400	200	0.13	20	39
500	250	0.16	20	39
1000	500	0.30	19	37
2000	1000	0.54	17	34

Ultimate static torque 130 in. lbs. calculated on 1,000 cycle basis.

C151806 (Counter Rotating)				
3 way : 2 to 1 : 1/2" shaft				
Angular velocity		Rated Power	Rated Torque	
Shaft 1	Shafts 2 & 3		Shaft 1	Shafts 2 and 3*
RPM	RPM	H.P.	In. Lbs.	In. Lbs.
100	50	0.02	16	32
200	100	0.05	16	32
300	150	0.08	16	32
400	200	0.11	16	32
500	250	0.14	16	32
1000	500	0.25	15	30
2000	1000	0.50	15	30

Ultimate static torque 116 in. lbs. calculated on 1,000 cycle basis.

\* This is the maximum torque that can be shared by both shafts (2 and 3) at once.

# CROWN RATED HORSEPOWER & TORQUE SPECIFICATIONS

## 3 Way

C105806				
3 way : 2 to 1 : 5/8" shaft				
Angular velocity		Rated Power	Rated Torque	
Shaft 1	Shaft 2		Shaft 1	Shaft 2
RPM	RPM	H.P.	In. Lbs.	In. Lbs.
100	50	0.06	34	68
200	100	0.11	34	68
300	150	0.16	34	68
400	200	0.22	34	68
500	250	0.27	34	68
1000	500	0.51	32	64
2000	1000	0.92	29	58

Ultimate static torque 210 in. lbs. calculated on 1,000 cycle basis.

C101806 (Counter Rotating)				
3 way : 2 to 1 : 5/8" shaft				
Angular velocity		Rated Power	Rated Torque	
Shaft 1	Shafts 2 & 3		Shaft 1	Shafts 2 and 3*
RPM	RPM	H.P.	In. Lbs.	In. Lbs.
100	50	0.05	31	62
200	100	0.08	30	60
300	150	0.12	28	56
400	200	0.18	28	56
500	250	0.21	26	52
1000	500	0.37	24	48
2000	1000	0.75	23	46

Ultimate static torque 192 in. lbs. calculated on 1,000 cycle basis.

\* This is the maximum torque that can be shared by both shafts (2 and 3) at once.

C205806				
3 way : 2 to 1 : 3/4" shaft				
Angular velocity		Rated Power	Rated Torque	
Shaft 1	Shaft 2		Shaft 1	Shaft 2
RPM	RPM	H.P.	In. Lbs.	In. Lbs.
100	50	0.11	70	140
200	100	0.22	70	140
300	150	0.33	70	140
400	200	0.44	70	140
500	250	0.55	70	140
1000	500	0.99	62	124
2000	1000	1.75	55	110

Ultimate static torque 540 in. lbs. calculated on 1,000 cycle basis.

## 3 Way

C805806				
3 way : 2 to 1 : 1" shaft				
Angular velocity		Rated Power	Rated Torque	
Shaft 1	Shaft 2		Shaft 1	Shaft 2
RPM	RPM	H.P.	In. Lbs.	In. Lbs.
100	50	0.38	236	472
200	100	0.75	236	472
300	150	1.00	210	420
400	200	1.33	210	420
500	250	1.67	210	420
1000	500	3.24	204	408
2000	1000	5.75	181	362

Ultimate static torque 2170 in. lbs. calculated on 1,000 cycle basis.

## 2 Way

C138801		
2 way : 1 to 1 : 3/8" shaft		
Angular velocity	Rated Power	Rated Torque
RPM	H.P.	In. Lbs.
100	0.04	25
200	0.08	25
300	0.12	25
400	0.16	25
500	0.20	25
1000	0.38	24
2000	0.67	21

Ultimate static torque 160 in. lbs. calculated on 1,000 cycle basis.

C156806		
2 way : 1 to 1 : 1/2" shaft		
Angular velocity	Rated Power	Rated Torque
RPM	H.P.	In. Lbs.
100	0.07	46
200	0.14	46
300	0.22	46
400	0.29	46
500	0.36	45
1000	0.71	45
2000	1.27	40

Ultimate static torque 275 in. lbs. calculated on 1,000 cycle basis.

C108806		
2 way : 1 to 1 : 5/8" shaft		
Angular velocity	Rated Power	Rated Torque
RPM	H.P.	In. Lbs.
100	0.16	101
200	0.32	101
300	0.47	99
400	0.62	98
500	0.75	95
1000	1.37	87
2000	2.43	77

Ultimate static torque 610 in. lbs. calculated on 1,000 cycle basis.

## 2 Way

C208806		
2 way : 1 to 1 : 3/4" shaft		
Angular velocity	Rated Power	Rated Torque
RPM	H.P.	In. Lbs.
100	0.30	189
200	0.56	177
300	0.81	171
400	1.06	167
500	1.33	167
1000	2.33	147
2000	4.25	134

Ultimate static torque 1400 in. lbs. calculated on 1,000 cycle basis.

C134801				
2 way : 2 to 1 : 3/8" shaft				
Angular velocity		Rated Power	Rated Torque	
Shaft 1	Shaft 2		Shaft 1	Shaft 2
RPM	RPM	H.P.	In. Lbs.	In. Lbs.
100	50	0.02	11	22
200	100	0.04	11	22
300	150	0.06	11	22
400	200	0.07	11	22
500	250	0.09	10	21
1000	500	0.16	10	20
2000	1000	0.30	9	18

Ultimate static torque 60 in. lbs. calculated on 1,000 cycle basis.

C154806				
2 way : 2 to 1 : 1/2" shaft				
Angular velocity		Rated Power	Rated Torque	
Shaft 1	Shaft 2		Shaft 1	Shaft 2
RPM	RPM	H.P.	In. Lbs.	In. Lbs.
100	50	0.03	20	39
200	100	0.06	20	39
300	150	0.09	20	39
400	200	0.13	20	39
500	250	0.16	20	39
1000	500	0.30	19	37
2000	1000	0.54	17	34

Ultimate static torque 130 in. lbs. calculated on 1,000 cycle basis.



# CROWN RATED HORSEPOWER & TORQUE SPECIFICATIONS

## 2 Way

C104806				
2 way : 2 to 1 : 5/8" shaft				
Angular velocity		Rated Power	Rated Torque	
Shaft 1	Shaft 2		Shaft 1	Shaft 2
RPM	RPM	H.P.	In. Lbs.	In. Lbs.
100	50	0.06	34	68
200	100	0.11	34	68
300	150	0.16	34	68
400	200	0.22	34	68
500	250	0.27	34	68
1000	500	0.51	32	64
2000	1000	0.92	29	58

Ultimate static torque 210 in. lbs. calculated on 1,000 cycle basis.

C204806				
2 way : 2 to 1 : 3/4" shaft				
Angular velocity		Rated Power	Rated Torque	
Shaft 1	Shaft 2		Shaft 1	Shaft 2
RPM	RPM	H.P.	In. Lbs.	In. Lbs.
100	50	0.11	70	140
200	100	0.22	70	140
300	150	0.33	70	140
400	200	0.44	70	140
500	250	0.55	70	140
1000	500	0.99	62	124
2000	1000	1.75	55	110

Ultimate static torque 540 in. lbs. calculated on 1,000 cycle basis.

Item Number	Overhung Load Capacity (at mid-shaft)				Thrust Load Capacity		Net Weight each	
	Shaft 1		Shafts 2 and 3		all shafts			
	Pounds of force	Newtons	Pounds of force	Newtons	Pounds of force	Newtons	Pounds	Kilograms
C100806	50.00	222.41	33.00	146.79	80.00	355.86	3.25	1.47
C101806	50.00	222.41	34.00	151.24	80.00	355.86	3.25	1.47
C104806	50.00	222.41	50.00	222.41	100.00	444.82	2.75	1.25
C105806	50.00	222.41	50.00	222.41	100.00	444.82	1.75	0.79
C108806	50.00	222.41	50.00	222.41	100.00	444.82	2.75	1.25
C109806	50.00	222.41	50.00	222.41	100.00	444.82	3.00	1.36
C130801	25.00	111.21	16.00	71.17	40.00	177.93	0.87	0.39
C134801	25.00	111.21	25.00	111.21	50.00	222.41	0.75	0.34
C135801	25.00	111.21	25.00	111.21	50.00	222.41	0.85	0.39
C138801	25.00	111.21	25.00	111.21	50.00	222.41	0.75	0.34
C139801	25.00	111.21	25.00	111.21	50.00	222.41	0.85	0.39
C150806	35.00	155.69	24.00	106.76	56.00	249.10	2.13	0.97
C151806	35.00	155.69	24.00	106.76	56.00	249.10	2.13	0.97
C154806	35.00	155.69	35.00	155.69	70.00	311.38	1.75	0.79
C155806	35.00	155.69	35.00	155.69	70.00	311.38	2.00	0.91
C156806	35.00	155.69	35.00	155.69	70.00	311.38	1.75	0.79
C157806	35.00	155.69	35.00	155.69	70.00	311.38	2.00	0.91
C204806	100.00	444.82	100.00	444.82	200.00	889.64	6.50	2.95
C205806	100.00	444.82	100.00	444.82	200.00	889.64	7.00	3.18
C208806	100.00	444.82	100.00	444.82	200.00	889.64	6.50	2.95
C209806	100.00	444.82	100.00	444.82	200.00	889.64	7.00	3.18
C803806	160.00	711.72	160.00	711.72	320.00	1423.43	18.00	8.16
C805806	160.00	711.72	160.00	711.72	320.00	1423.43	18.00	8.16

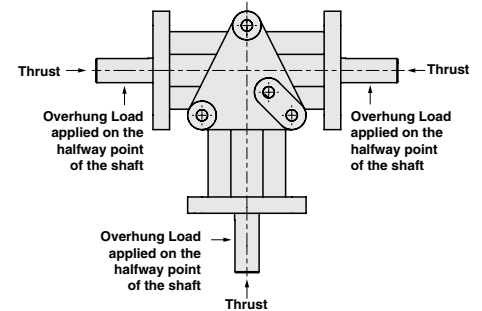
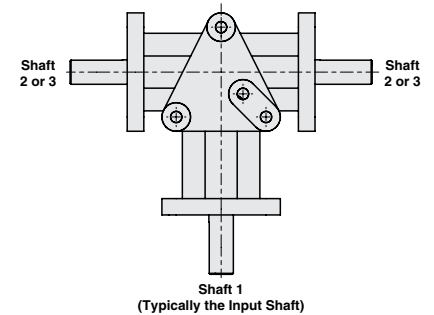

New Zero-Max  
Configurable  
3D CAD Downloads.

[www.zero-max.com](http://www.zero-max.com)



**ServoClass® Couplings**  
Designed for demanding servomotor applications. Zero backlash, high torsional stiffness coupling. Features flexible metal discs and keyless clamp-type mounting hubs. Couplings are RoHS compliant.



**ETP® Shaft Locking Connections**  
Designed for quick, easy and accurate assembly of mounted shaft components. Both inch and metric bore connections are available from stock.



**CD® Couplings**  
These high performance couplings out last bellows and steel disc design couplings. The unique design of the composite disc enables the CD Couplings® to withstand punishing applications and deliver high precision performance.



**Roh'Lix® Linear Actuators**  
Roh'Lix® Linear Actuators convert rotary motion into precise linear motion. Available in five models. Roh'Lix® actuators have thrust ratings from 5 to 200 lbs. All models feature built in overload protection.



**Schmidt® Offset Couplings**  
Schmidt® Offset Couplings are designed to handle high amounts of parallel offset up to 17.00". Standard models with torque capacities up to 459,000 in-lbs.



**Adjustable Speed Drives**  
Easy to install and maintenance free. Zero-Max Drives offer infinitely variable speeds from 0 rpm to 1/4 of input rpm. 5 models with torque ranges from 12 in-lbs to 200 in-lbs.



**Overload Safety Couplings**  
Torq-Tender® Couplings provide reliable overload protection in any mechanical power transmission system. Torque ranges from 2 to 3000 in-lbs.



**Crown® Gear Drives**  
Crown® Gear Drives are available with 1:1 and 2:1 ratios. High quality AGMA class 10 spiral bevel gears. Stainless steel shafts and aluminum housings are standard on all Crown® Gear Drives.



**Control-Flex® Couplings**  
Control-Flex® Couplings are zero backlash couplings designed for encoder and instrumentation type applications.



**OHLA® Overhung Load Adapters**  
OHLA® Overhung Load Adapters are designed to eliminate radial and axial loads from a hydraulic pump or motor. 20 models available for mounts from SAE A to SAE F.

Warranty. Zero-Max, Inc. the manufacturer, warrants that for a period of 12 months from date of shipment it will repair, or at its option, replace any new apparatus which proves defective in material or workmanship, or which does not conform to applicable drawings and specifications approved by the manufacturer. All repairs and replacements shall be F.O.B. factory. All claims must be made in writing to the manufacturer. ● In no event and under no circumstances shall manufacturer be liable for (a) damages in shipment; (b) failures or damages due to misuse, abuse, improper installation or abnormal conditions of temperature, dirt, water or corrosives; (c) failures due to operation, intentional or otherwise, above rated capacities, and (d) non-authorized expenses for removal, inspection, transportation, repair or rework. Nor shall manufacturer ever be liable for consequential and incidental damages, or in any amount greater than the purchase price of the apparatus. ● Zero Max, Inc. reserves the right to discontinue models or to change specifications at any time without notice. No discontinuance or change shall create any liability on the part of Zero-Max, Inc. in respect to its products in the hands of customers or products on order not incorporating such changes even though delivered after any such change. ● This warranty is in LIEU OF ALL OTHER WARRANTIES, EXPRESS OR IMPLIED, INCLUDING (BUT NOT LIMITED TO) ANY IMPLIED WARRANTIES OF MERCHANTABILITY OR FITNESS FOR A PARTICULAR PURPOSE. THE TERMS OF THIS WARRANTY CONSTITUTE ALL BUYER'S OR USER'S SOLE AND EXCLUSIVE REMEDY, AND ARE IN LIEU OF ANY RIGHT TO RECOVER FOR NEGLIGENCE, BREACH OF WARRANTY, STRICT TORT LIABILITY OR UPON ANY OTHER THEORY. Any legal proceedings arising out of the sale or use of this apparatus must be commenced within 18 months of the date of purchase. ● CAUTION: Rotating equipment must be guarded. Also refer to OSHA specifications and recommendations. ● Zero-Max®, CD®, ETP®, ServoClass®, Torq-Tender®, Control-Flex®, Posi-Lok®, Roh'Lix®, Crown®, Schmidt® and OHLA® are registered trademarks of Zero-Max, Inc. In U.S.A.

©Zero-Max, Inc., All Rights Reserved  
Printed in U.S.A., Rev1.03W

**ZERO-MAX®**

13200 Sixth Avenue North, Plymouth, Minnesota 55441-5509  
Phone 800.533.1731 763.546.4300 FAX 763.546.8260

zero-max.com